

# Fuji Gas Analyzers



# Conservation of sound environment is also our important task.

Our company commercialized an infrared type gas analyzer in 1954 and recently has developed unique analyzers one after another as represented by a CO/O<sub>2</sub> analyzer for monitoring of dioxins emission regulation and a simultaneous multi-component gas analyzer in order to enrich the product lineup.

Our company will continue offering analytical instruments helpful for protection of the global environment through the integration of new technologies and long experience.

## INFRARED GAS ANALYZER best suited for measuring exhaust gas in stack

Simultaneous Measurement of 5 components; NO<sub>x</sub>, SO<sub>2</sub>, CO, CO<sub>2</sub> and O<sub>2</sub>

Type: ZSU



CO, O<sub>2</sub> Gas Analyzer for stack gas

Type: ZSQ



Simultaneous Measurement of 7 components; NO<sub>x</sub>, SO<sub>2</sub>, HCl, CO, CO<sub>2</sub>, O<sub>2</sub>, Soot and Dusts

Type: ZSU-7



Compact Type NO<sub>x</sub>, SO<sub>2</sub>, CO, CO<sub>2</sub> and O<sub>2</sub> GAS ANALYZER

Type: ZSVF



## CO GAS ANALYZER for Air pollution monitoring

CO GAS ANALYZER for Automobile tunnel

Type: ZSA



## CO<sub>2</sub> CONTROLLER

best suited for building ventilation and green house

Type: ZFP



## CROSS STACK LASER GAS ANALYZER

Fast measurement of NH<sub>3</sub> Gas or HCl, H<sub>2</sub>O, CO, CO<sub>2</sub>, CH<sub>4</sub>, O<sub>2</sub> Gas concentration in Stack

Type: ZSS

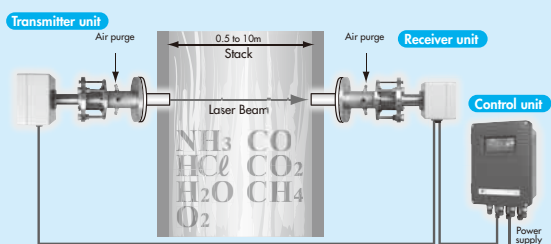

## CO, CO<sub>2</sub>, CH<sub>4</sub> ANALYZER

Type: ZFG



## OXYGEN ANALYZER SERIES best suited for combustion control and energy saving

### IN-SITU ZIRCONIA OXYGEN ANALYZER

Type: ZSB

Type: ZKM1

Type: ZKM2

Type: ZKME

Type: ZFK8



(Detector)

(Converter)

(Converter)

(Converter)

### Fast response type PARAMAGNETIC ANALYZER

Type: ZAJ

Type: ZKG



# ANALYZER best suited for measuring atmosphere gas in heat treatment furnace

## ● INFRARED system

### Single beam type

CO, CO<sub>2</sub>, CH<sub>4</sub>, SO<sub>2</sub>, NO<sub>x</sub> and O<sub>2</sub> measuring, 4-component analyzer

Type: ZRJ



NO<sub>x</sub>, SO<sub>2</sub>, CO, CO<sub>2</sub>, CH<sub>4</sub> and O<sub>2</sub> measuring, 5-component analyzer

Type: ZRE



### Dual beam type

NO<sub>x</sub>, SO<sub>2</sub>, CO, CO<sub>2</sub> and CH<sub>4</sub> measuring, 5-component analyzer

Type: ZKJ



NO<sub>x</sub>, SO<sub>2</sub>, CO, CO<sub>2</sub> measuring, 1-component analyzer

Type: ZRC6



## ● THERMAL CONDUCTIVITY system

### GAS ANALYZER

He, Ar, and H<sub>2</sub> measuring

Type: ZAF



### Easy-to-carry PORTABLE TYPE

CO, CO<sub>2</sub>, CH<sub>4</sub>, O<sub>2</sub> analyzer

Type: ZSVS



Automobile exhaust gas analyzer for measurement of HC, CO, CO<sub>2</sub> and O<sub>2</sub>

Type: ZKE



Satisfactory products for customers will be delivered under strict quality control.

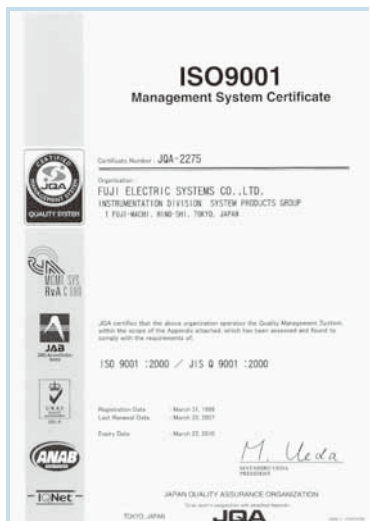

ISO 9001 certification already obtained: Registration certificate No. JQA-2275

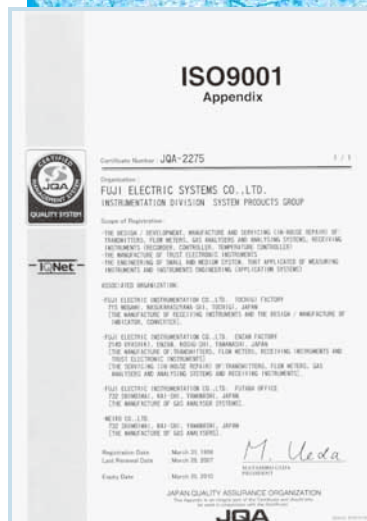

ISO 14001 certification already obtained: Registration certificate No. JQA-EM2492



"Status of manufacturer specified in the Measurement Law" already acquired: Specification No. 391901



# INFRARED GAS ANALYZER

*Is the air really safe?*

*Yes. Because a gas analyzer keeps an eye on pollutant gases.*

## Simultaneous Measurement of NO<sub>x</sub>, SO<sub>2</sub>, CO, CO<sub>2</sub> and O<sub>2</sub> for stack gas



Type: ZSU

Japanese pattern approval  
SAS992-1 (SO<sub>2</sub> meter)  
SAC992-1 (CO meter)  
SAN991-1 (NO<sub>x</sub> meter)  
SE981 (O<sub>2</sub> meter)  
SF011 (O<sub>2</sub> meter)

## Simultaneous Measurement of CO, O<sub>2</sub> Gas Analyzer for stack gas



Type: ZSQ

Japanese pattern approval  
SAC984 (CO meter)  
SE981 (O<sub>2</sub> meter)

### FEATURES

- Measurement by the infrared ray method (dual beam optics) excellent in long-term stability.
- Hardly affected by unintended gases because interference components' influence is corrected with twin detectors.
- Standard-equipped with automatic zero/span calibrating function.
- Space saving design allowing maintenance from the front of each analyzer.

### SPECIFICATIONS

- Measuring object: Exhaust gas of Incinerator and boiler, etc.
- Measurable components: NO<sub>x</sub>, SO<sub>2</sub>, CO, CO<sub>2</sub>, O<sub>2</sub>
- Measuring system: Dual beam type infrared method (O<sub>2</sub>: Zirconia method or Paramagnetic method)
- Measurement range: NO<sub>x</sub>: 0 to 50 ..... 5000ppm  
SO<sub>2</sub>: 0 to 50 ..... 5000ppm  
CO: 0 to 50 ..... 5000ppm  
CO<sub>2</sub>: 0 to 10 / 0 to 20%  
O<sub>2</sub>: 0 to 10 / 0 to 25vol%
- Repeatability: ±0.5%FS
- Linearity: ±1%FS
- Zero/span drift: ±2%FS/week (O<sub>2</sub>: ±2%/month)
- Response time: NO<sub>x</sub>, CO, CO<sub>2</sub>, O<sub>2</sub>: 2 minutes, SO<sub>2</sub>: 4 minutes (90% response, from the device inlet)
- Output signal: 4 to 20mA DC
- Contact output: Auto calibration status, maintenance status, concentration alarm, CO peak count alarm, range identification of each component, etc.
- Contact input: Auto calibration start, range changeover, pump ON-OFF, etc.
- Function: Auto calibration, O<sub>2</sub> correction, average value calculation, concentration alarm, CO peak count alarm, etc.
- Display: LCD with back light
- Recorder: 6-point recorder mounted (option)
- Power supply : 100V, 110V, 115V, 200V or 230V AC
- Outer dimensions: 800(W) x 1710(H) x 615(D) mm

### FEATURES

- Measurement by the infrared ray method (single beam optics) excellent in long-term stability.
- Provided with CO peak count alarm and self-diagnostic function.
- Standard-equipped with automatic zero/span calibrating function.
- Space saving design allowing maintenance from the front of each analyzer.

### SPECIFICATIONS

- Measuring object: Exhaust gas of incinerator, etc.
- Measurable components: CO, O<sub>2</sub>
- Measuring system: Single beam type infrared method (O<sub>2</sub>: Zirconia method)
- Measurement range: CO: 0 to 200 ..... 2000ppm  
O<sub>2</sub>: 0 to 25vol%
- Repeatability: ±0.5%FS
- Linearity: ±1%FS
- Zero/span drift: ±2%FS/week (O<sub>2</sub>: ±2%/month)
- Response time: 90 seconds (90% response, from the device inlet)
- Output signal: 4 to 20mA DC
- Contact output: CO peak count alarm, auto calibration status, error status, etc.
- Function: Auto calibration, O<sub>2</sub> correction, average value calculation, CO peak count alarm, etc.
- Display: LCD with back light
- Recorder: 6-point recorder mounted (option)
- Power supply: 100V AC, 50/60Hz (110 to 240V AC: transformer built in)
- Outer dimensions: 600(W) x 1580(H) x 675(D) mm

**Gas Sampling System Diagram example (ZSU type)**

**Gas extractor (ZBAK type)**



**SPECIFICATIONS**

- Temperature of gas used:  
Max 800°C (SUS extraction tube)  
Max 1500°C (SIC extraction tube)
- System: Electrical heating
- Material of extraction tube:  
SUS 316, or SIC + SUS 316
- Length of extraction tube:  
600 to 2000mm
- Mounting method: JIS 5K 65A flange
- Filter: SUS 316 wire mesh
- Sampling gas outlet: RC1/4
- Power supply voltage: 100V AC, 100 VA (for built-in heater)

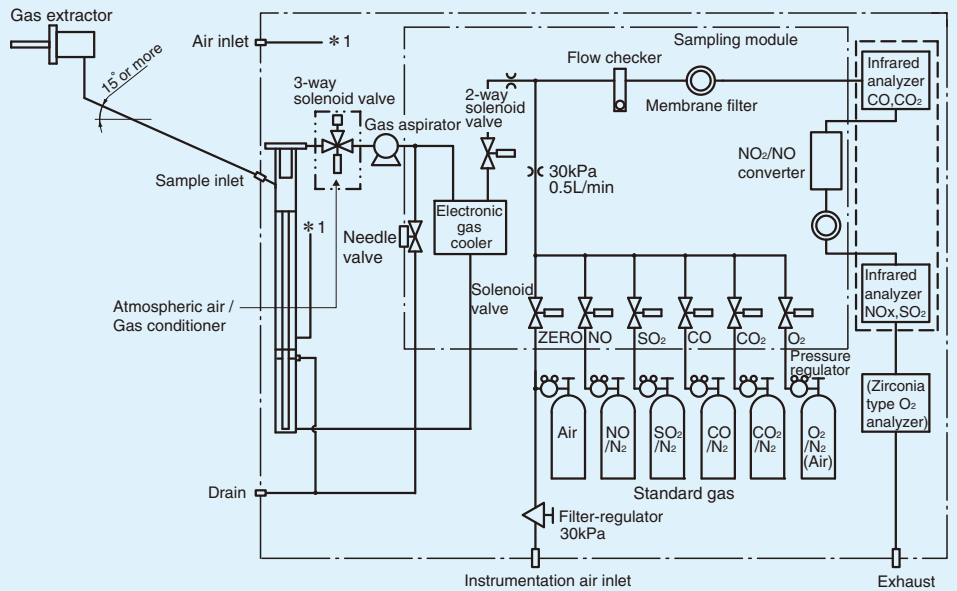

**Simultaneous Measurement of NO<sub>x</sub>, SO<sub>2</sub>, HCl, CO, CO<sub>2</sub>, O<sub>2</sub>, Soot and Dusts for stack gas**

**Type: ZSU-7**



- Japanese pattern approval  
SAS992-1 (SO<sub>2</sub> meter)  
SAC992-1 (CO meter)  
SAN991-1 (NO<sub>x</sub> meter)  
SE981 (O<sub>2</sub> meter)  
SF011 (O<sub>2</sub> meter)

**FEATURES**

- Measurement can be taken by the infrared ray method (single beam type) having excellent stability and maintainability.

- All functions are included in the small locker of 600 (W) × 515 (D) × 1710 (H) mm.
- Zero and span auto calibration function is equipped as standard.
- Space-saving configuration that is accessible for maintenance on the front panel of the analyzer.

**SPECIFICATIONS**

- Measuring object: Exhaust gas of Incinerator and boiler, etc.
- Measurable components: NO<sub>x</sub>, SO<sub>2</sub>, HCl, CO, CO<sub>2</sub>, O<sub>2</sub>, Soot and Dusts
- Measuring system: Dual beam type infrared method  
(O<sub>2</sub>: Zirconia method, HCl: Laser method)
- Measurement range: NO<sub>x</sub>: 0 to 50 ..... 5000ppm  
SO<sub>2</sub>: 0 to 50 ..... 5000ppm  
HCl : 0 to 15ppm·m ..... 5000ppm·m  
CO: 0 to 50 ..... 5000ppm  
CO<sub>2</sub>: 0 to 10 / 0 to 20%  
O<sub>2</sub>: 0 to 10 / 0 to 25vol%  
Soot and Dusts: 0.01 to 1000mg/m<sup>3</sup>
- Repeatability: ±0.5 FS (infrared method),  
±2% FS (Laser method)
- Zero/span drift: ±2%FS/week  
(O<sub>2</sub>: ±2% FS/month HCl : ±2% FS)
- Response time: NO<sub>x</sub>, CO, CO<sub>2</sub>, O<sub>2</sub>: 2 minutes,  
SO<sub>2</sub>: 4 minutes  
HCl : 1 to 5 sec.  
(90% response, from the device inlet)
- Output signal: 4 to 20mA DC
- Contact output: 8 point (Auto calibration status, maintenance status, concentration alarm etc.)
- Contact input: Auto calibration start, range changeover etc.
- Recorder: Paperless recorder mounted (option)
- Power supply: 100V, 110V, 115V, 200V or 230V AC
- Outer dimensions: 1215(W) × 1780(H) × 700(D) mm

**Simultaneous Measurement of NO<sub>x</sub>, SO<sub>2</sub>, CO, CO<sub>2</sub> and O<sub>2</sub> for stack gas**

**Type: ZSVF**



**FEATURES**

- A maximum 5 components out of NO<sub>x</sub>, SO<sub>2</sub>, CO, CO<sub>2</sub>, CH<sub>4</sub> and O<sub>2</sub> can be measured simultaneously.
- The large LCD screen with clear display assures simple operation.
- Single-beam infrared gas analyzer having excellent stability is adopted.
- The separate structure allows the analyzer unite and the pretreatment unit to be placed separately.
- Measurement can be taken continuously for up to 5 days.

**SPECIFICATIONS**

- Measuring object: Combustion exhaust gas measurement, etc.
- Measurable components: NO<sub>x</sub>, SO<sub>2</sub>, CO, CO<sub>2</sub>, CH<sub>4</sub>, O<sub>2</sub>
- Measuring system: Single beam type infrared method  
(O<sub>2</sub>: Paramagnetic method or galvanic method)
- Measurement range: NO<sub>x</sub>: 0 to 500 ..... 5000ppm  
SO<sub>2</sub>: 0 to 500 ..... 1%  
CO: 0 to 200 ..... 100%  
CO<sub>2</sub>: 0 to 200 ..... 100%  
CH<sub>4</sub>: 0 to 2000ppm ..... 100%  
O<sub>2</sub>: 0 to 5 / 25%
- Repeatability: ±0.5%FS
- Linearity: ±2%FS
- Zero/span drift: ±1%FS/day
- Response time: 50 second for 90% response from the device inlet but 3 minutes for SO<sub>2</sub>
- Output signal: 4 to 20mA DC or 0 to 1V DC
- Communication function: RS-232C (MODBUS)
- Functions: Auto calibration, O<sub>2</sub> correction, average value calculation
- Indication: LCD with back light
- Power supply: 100 to 115V AC or 200 to 240V AC, 50/60Hz
- Outer dimensions: 365(W) × 574(H) × 514(D) mm

# CROSS STACK Laser Gas Analyzer

*Fast measurement of NH<sub>3</sub> Gas or HCl, O<sub>2</sub>, H<sub>2</sub>O, CO, CO<sub>2</sub>, CH<sub>4</sub> Gas concentration in Stack*

Type: ZSS

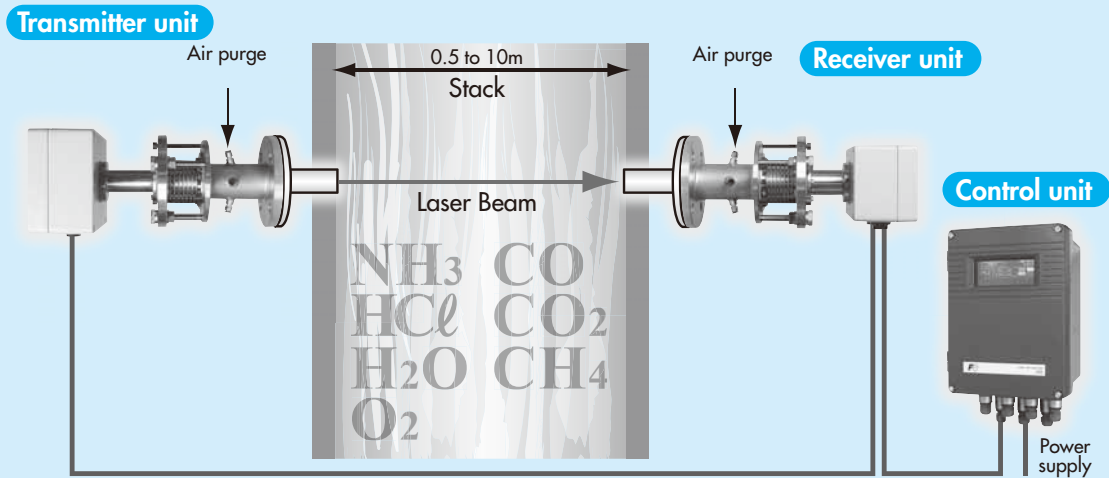

## FEATURES

- Excellent Long-term Stability, and Maintenance-free!
- Zero drift:  $\pm 2.0\%$ FS
- Highly absorptive and corrosive gasses can be measured in low concentration.
- Usable in high temperature and dusty environment.
- Fast response (1 to 5 sec.) is available, and integration with the control system is feasible.

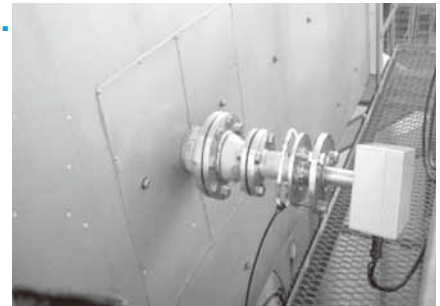

## Measurable components measurable range

Measurable components,	Min. measuring range	Max. measuring range
HCl	10ppm	5000ppm
NH <sub>3</sub>	15ppm	5000ppm
HCl+H <sub>2</sub> O	50ppm(HCl)	1000ppm(HCl) Note 1)
NH <sub>3</sub> +H <sub>2</sub> O	50ppm(NH <sub>3</sub> )	1000ppm(NH <sub>3</sub> ) Note 1)
O <sub>2</sub>	4vol%	50vol%
CO	2vol%	50vol%
CO <sub>2</sub>	2vol%	50vol%
CO+CO <sub>2</sub>	2.5vol%	50vol%
CH <sub>4</sub>	100ppm	50vol%

Note 1) The H<sub>2</sub>O range is fixed to 50 vol%.

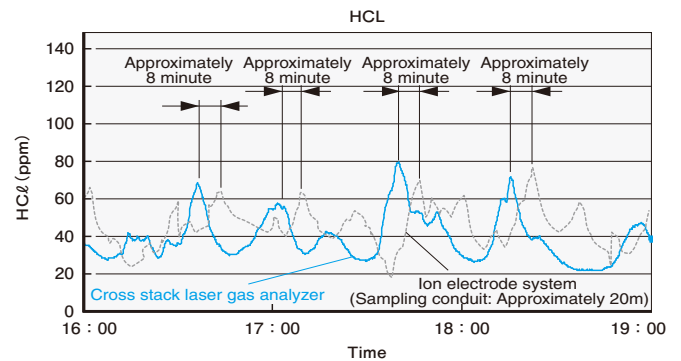

## Case example of field measuring data



## SPECIFICATIONS

Measurable gas	HCl, NH <sub>3</sub> , HCl+H <sub>2</sub> O, NH <sub>3</sub> +H <sub>2</sub> O, O <sub>2</sub> CO, CO <sub>2</sub> , CH <sub>4</sub> , CO+CO <sub>2</sub>	Contact output	5 items (Outside the range of upper/lower limits, insufficient quantity of light received, device fault, on hold)
Measurement principle	Non-dispersive infrared absorbance system(NDIR)	Power supply voltage	100 to 240VAC approx. 70VA
Installation system	Cross stack system	Ambient temperature	Receiver/transmitter units -20 to 55°C, Controller unit -5 to 45°C, 90%R.H. or less
Laser class	CLASS 1M	Measuring gas temperature	1200°C max.
Measuring light path length	0.5 to 10m (stack/smokestack width)	Measuring gas pressure	$\pm 10$ kPa
Repeatability	$\pm 2.0\%$ FS	Outside dimensions (D×W×H)mm	Receiver unit (180×400×200mm) Transmitter unit (240×400×200mm) Controller unit (135×240×320mm)
Zero/span drift	$\pm 2.0\%$ FS (NH <sub>3</sub> $\pm 3.0\%$ FS when range is 20ppm or less)	Mass	Receiver/transmitter units (approx. 10kg each), control unit (approx. 8kg)
Response time	1 to 5 seconds(90% response)	Mounting method	Control unit (mounting on wall or piping), receiver/transmitter units (mounting on flange)
Analog output	4 to 20mADC, 0 to 1VDC, 0 to 5VDC or 0 to 10VDC (depending on specification)		
Analog input	4 to 20mADC (2 or 6 points)		
Communication function	USB or RS-485 (MODBUS)		
Contact input (option)	3 items (Average value reset, remote hold, remote range switching, instantaneous value/average value switching)		

# Infrared Type Gas Analyzer (Component)

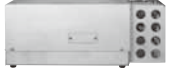
Measuring method		Single beam system		Dual beam system	
Type		ZRE	ZRJ	ZKJ	ZRC6
Appearance					
Measurable gas components & minimum range	NO	0 to 200ppm	0 to 500ppm	0 to 50ppm	0 to 100ppm
	SO <sub>2</sub>	0 to 200ppm	0 to 500ppm	0 to 50ppm	0 to 100ppm
	CO	0 to 200ppm	0 to 200ppm	0 to 50ppm	0 to 100ppm
	Low concentrationCO	—	—	—	—
	CO <sub>2</sub>	0 to 100ppm	0 to 500ppm	0 to 20ppm	0 to 50ppm
	CH <sub>4</sub>	0 to 500ppm	0 to 1000ppm	0 to 200ppm	—
	O <sub>2</sub> meter built in	0 to 5%	0 to 5%	0 to 5%	—
Number of measurable gas components		1 to 5	1 to 4	1 to 5	1
Repeatability		0.5% of full scale			
Zero drift		Within 2% of full scale/week			
Span drift		Within 2% of full scale/week			
Response speed (90% response)		Within 60 seconds	Within 15 seconds / 2 components Within 30 seconds / 4 components	Within 60 seconds	Within 20 seconds
Analog output	4 to 20mA DC	●	●	●	●
Analog output	0 to 1V DC	●	●	●	●
Communication interface		●RS485 (Option)	●RS232C (Option)	●RS232C (Option)	—
Contact output		●	●	●	—
Contact input		●Option	●	●	●
Indication		LCD with back light	LCD with back light	LCD with back light	—
Function	Automatic calibration	●Option	●	●	—
	Upper/lower limit alarm	●Option	●	●	—
	Average calculation	●Option	●Option	●Option	—
	O <sub>2</sub> correction	●Option	●Option	●Option	—
	CO peak count	—	●Option	●Option	—
Power supply		100 to 240V AC	100 to 240V AC	100 to 240V AC	100 to 240V AC
Outer dimensions (W x H x D) mm		483×133×418	483×177×493	483×177×690	433×176×229

## Compact type infrared gas analyzer

Type: ZSVS



### FEATURES

- The gas concentrations of 4 components among CO<sub>2</sub>, CO, CH<sub>4</sub> and O<sub>2</sub> measured simultaneously and continuously with a single gas analyzer.
- Transportable with built-in pump, filter and flow meter.
- Provided with computation functions such as CP calculation, O<sub>2</sub> correction, moving average, etc.
- Smooth operation in an interactive way through a large-size LCD.
- Excellent in long-term stability and easy maintenance using single beam system.

### SPECIFICATIONS

- Measurable components: CO<sub>2</sub>, CO, CH<sub>4</sub> and O<sub>2</sub>
- Measuring system: Single beam type infrared method (O<sub>2</sub>: galvanic cell method)
- Measurement range: 0 to 200 -----100%CO<sub>2</sub>  
0 to 200 -----100%CO  
0 to 100 -----100%CH<sub>4</sub>  
0 to 5/25%O<sub>2</sub>
- Numbers of range: Max. 3 ranges
- Measurable components:Max. 4 components
- Repeatability: Drift: Within ±1.0% of full scale/day
- Response time: Less than 50 seconds (90% response from the gas inlet)
- Output signal: 4 to 20mA DC or 0 to 1V DC
- Communication function: RS232C (MODBUS)
- Standard function: CP calculation, O<sub>2</sub> correction, O<sub>2</sub>-corrected moving average value, automatic OFF, etc.
- Indication: LCD with back light
- Outer dimensions: 365(W) x 211(H) x 527(D) mm
- Power-supply voltage: 100 to 115V AC or 200 to 240V AC



# ZIRCONIA OXYGEN ANALYZER

This type of oxygen analyzer is capable of measuring oxygen gas even without a gas aspirator, gas cooler, etc. Optimum for combustion control of boiler, refuse incinerator, sludge incinerator, heating furnace, etc.

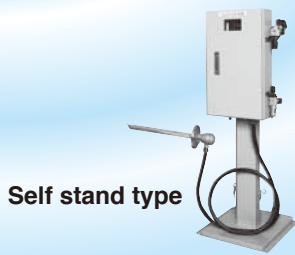
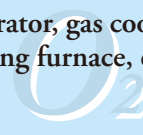

Self stand type



IP66 Type



IP67 Type



Frame-proof Type

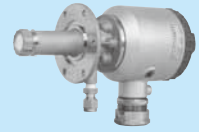

Detecting unit

Self-stand type accommodating necessary devices.



Type: ZSB

Compact and High capacity

Detector type: ZFK8

type: ZKM1

type: ZKM2



## FEATURES

- Automatic calibration and manual/auto blow-down functions are provided. A solenoid valve and other necessary devices are incorporated.
- Measuring range is freely settable within 2 to 50%.
- Incomplete combustion level indication is selected when oxygen becomes inadequate.

## SPECIFICATIONS

- Measuring object: Oxygen in combustion exhaust gas
- Measuring range: 0 to 2----50vol% O<sub>2</sub> (freely settable)
- Repeatability: ±0.5%FS
- Linearity: ±2%FS
- Response time: Within 10 seconds (From calibration gas inlet)
- Oxygen concentration output signal: 4 to 20mA DC or 0 to 1V DC
- Contact output: 4 points (1a relay contact) Upper/lower limit alarm, maintenance status, blow down status, contact output during calibration
- Contact input: Auto calibration start, inhibit calibration
- Indication: Oxygen concentration display (3-digit LED), mode display (3pcs LED), operation/setting display(16-digit, 2-line LCD)
- Combustion efficiency display: Option
- Communication interface: RS485 (option)
- Calibration method: Automatic, manual by key operation, input from external contact
- Power supply: 100, 115 or 230V AC 50/60Hz
- Construction: Pipe stand type or wall mounting type
- Cable length from converter part to detector: 20m, max.

## FEATURES

- Modular detector design allows easy field replacement of zirconia element.
- High-speed response of 4 to 7 seconds.
- Case structure available in two types: IP66 and IP67.
- May be programmed without opening the case cover (ZKM1).

## SPECIFICATIONS

- Measuring object: Oxygen in combustion exhaust gas
- Measuring range: 0 to 2----50vol% O<sub>2</sub> (freely settable)
- Repeatability: ±0.5%FS
- Linearity: ±2%FS
- Response time: 4 to 7seconds (from inlet for calibration gas)
- Oxygen concentration output signal: 4 to 20mA DC or 0 to 1V DC
- Contact output: 6 points (1a relay contact) Alarm, instrument error, under maintenance, under blow down, zero gas span for out put calibration.
- Input contact: 3 points (no voltage contact) Blow down, starting calibration, heater OFF, range change, external hold
- Concentration value indication: Digital indication in 4 digits
- Combustion efficiency display: Option
- Communication function RS232C or RS485 (MODBUS)
- Calibration method: Automatic, manual by key operation, input from external contact
- Power supply: 100 to 120V AC or 200 to 240V AC 50/60Hz
- Mounting method : Mounting on panel surface, or pipe stand
- Cable length from converter part to detector: 100m, max.

### ZKM-type System Diagram

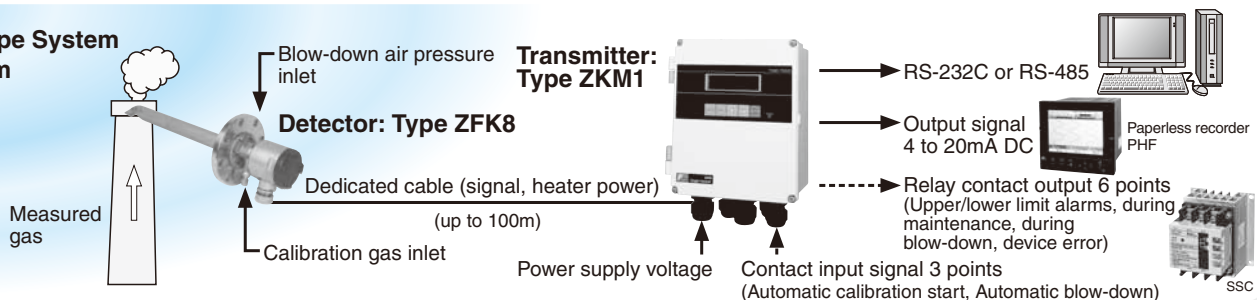



A flow guide tube skillfully utilizing the flow of the measured gas assures fast response.

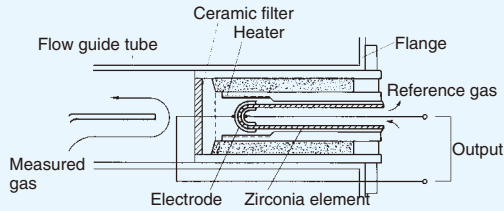

Detectors applicable for various fields

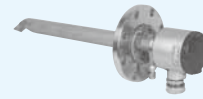

Standard type

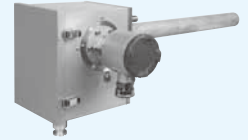

800 to 1500°C:  
with ejector

Various combinations of detector and flow guide tube have been prepared for use under different site conditions.

Note) Blow-down refers to a function for blowing away the dust accumulating in the flow guide tube of detector unit by compressed air.

Application	Temperature	Gas flow	Dust	Remarks	Adaptable detector/flow guide tube	Mounting method
Boiler, etc. (General-purpose)	600°C or less	5 to 20m/s	Below 0.2g/Nm <sup>3</sup>	Fuel: Gas, oil	General-purpose	JIS 5K 65A
			Below 10g/Nm <sup>3</sup>	Fuel: Coal	With blow-down nozzle	JIS 5K 80A
Garbage incinerator, Sludge incinerator (For anti-corrosion)	600°C or less	5 to 20m/s	Below 1g/Nm <sup>3</sup>	Small amount of moisture in gas	For anti-corrosion	JIS 5K 65A
			Below 10g/Nm <sup>3</sup>		For anti-corrosion with blow-down nozzle	JIS 5K 80A
			Below 25g/Nm <sup>3</sup>		For anti-corrosion high dust	JIS 5K 80A
Heating furnace (General-purpose)	800°C or less	1m/s or less	Below 1g/Nm <sup>3</sup>	Small amount of moisture in gas	With ejector	JIS 10K 65A
	1500°C or less	1m/s or less	Below 1g/Nm <sup>3</sup>		With ejector	JIS 10K 65A

## Flame-proof type

Detector type: ZFKE

Converter type: ZKME



## Zirconia O<sub>2</sub> analyzer for ZRJ, ZKJ, ZRE (Built-in type)

Type: ZFK7



## FEATURES

- Modular detector design allows easy field replacement of zirconia element.
- High-speed response of 4 to 7 seconds.
- May be programmed without opening the case cover.
- Flame-proof type available for explosive atmospheres  
TIIS Exd IIB T6, NEPSI/Exd IIC T6 ExII2G

## SPECIFICATIONS

- Measuring object: Oxygen in combustion exhaust gas
- Measuring range: 0 to 2-----50vol% O<sub>2</sub> (freely settable)
- Repeatability: ±0.5%FS
- Linearity: ±2%FS
- Response time: 4 to 7seconds (from inlet for calibration gas)
- Oxygen concentration output signal: 4 to 20mA DC or 0 to 1V DC
- Contact output: 6 points (1a relay contact)  
Alarm, instrument error, under maintenance, under blow down, zero gas span for out put calibration.
- Input contact: 3 points (no voltage contact)  
Blow down, starting calibration, heater OFF, range change, external hold
- Concentration value indication: Digital indication in 4 digits
- Combustion efficiency display: Option
- Communication function RS232C or RS485 (MODBUS)
- Calibration method: Automatic, manual by key operation, input from external contact
- Power supply: 100 to 120V AC or 200 to 240V AC 50/60Hz
- Mounting method : Mounting on panel surface
- Cable length from converter part to detector: 100m, max.

The combination table of NDIR gas analyzer and Zirconia O<sub>2</sub> analyzer

NDIR gas analyzer	Zirconia O <sub>2</sub> analyzer
ZRJ	ZFK7
ZKJ	ZFK7
ZRE	ZFK7

## SPECIFICATIONS

- Measuring system: Zirconia method
- Measurement range: 0 to 25%
- Repeatability: ±0.5%FS
- Zero drift: ±1%FS/week
- Span drift: ±2%FS/week
- Response time: Within 20 seconds (From calibration gas inlet)
- Power supply: 100 to 115V AC or 200 to 240V AC, 50/60Hz
- Outer dimensions: 170(W) x 140(H) x 190(D) mm

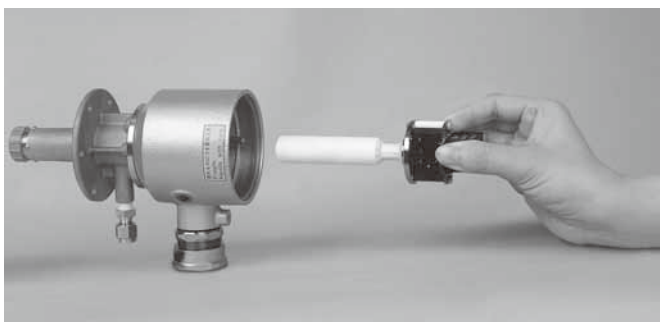

Easily replaceable zirconia element

# PARAMAGNETIC OXYGEN ANALYZER

Paramagnetic oxygen analyzers maintaining quick response unaffected by combustible gases. Most suited for combustion control of heat treatment furnaces and combustion furnaces, and for chemical experiment.

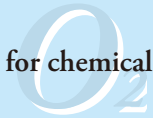

Fast response type



Reference gas needless type

## 2-second fast response ZAJ-type

Type: ZAJ



### FEATURES

- Response as high as 2 seconds.
- Hardly affected by other gases (such as H<sub>2</sub> and CO<sub>2</sub>).
- A suppression range such as 21 to 100% O<sub>2</sub> is settable.
- Gas-contacting parts are made of corrosion-resisting material
- Automatic calibration function and communication function can be incorporated (at option).

### SPECIFICATIONS

- Measuring principle: Paramagnetic method (Pressure detect type)
- Measurement range: (1) When reference gas is N<sub>2</sub>  
0 to 2 -----100%O<sub>2</sub> (freely settable)  
(2) When reference gas is air  
21 to 23 -----100%O<sub>2</sub> or  
21 to 19 -----0%O<sub>2</sub> (freely settable)  
(3) When reference gas is 100%O<sub>2</sub>  
100 to 98 -----0%O<sub>2</sub> (freely settable)
- Numbers of range: 2 ranges
- Repeatability: ±0.5%FS (in 10%O<sub>2</sub> or higher range)
- Linearity: ±2%FS
- Response time: Within 2 seconds (From sample gas inlet)
- Oxygen concentration output signal: 4 to 20mA DC or 0 to 1V DC
- Moving average time: 0 to 99.9 seconds
- Contact output: 2 points (1a relay contact) Calibration status, contact output of analyzer error
- Contact input (Option): Remote range changeover, output hold
- Indication: LCD display, Oxygen concentration display (4-digit), range display (4-digit), message display (24-digit, 2-line)
- Alarm output: Upper/lower limit alarm (Option)
- Communication interface: RS232 (Option)
- Automatic calibration method: Zero/span automatic calibration function (option)
- Power supply: 100 to 240V AC, 50/60 Hz
- Mounting method: Mounting on 19-inch rack, flush mounting on panel or desk top mounting

### ● ZAJ Type Gas Sampling System Diagram (Combustion exhaust gas example)

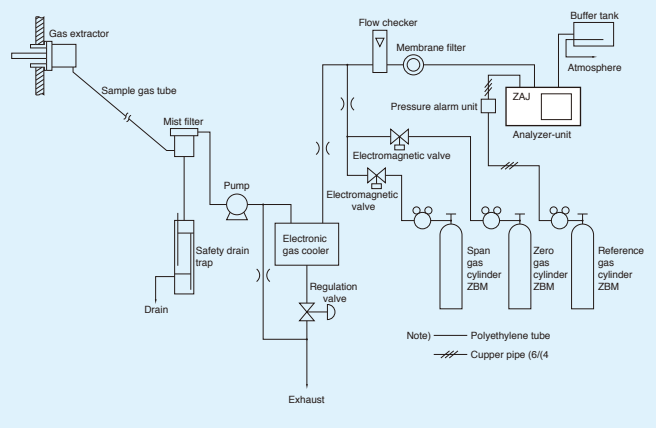

### ● ZAJ Type Measuring Principle Diagram

When the measured gas is placed in a magnetic field, oxygen molecules will be attracted. This gives rise to a pressure, which is detected by a mass flow sensor.

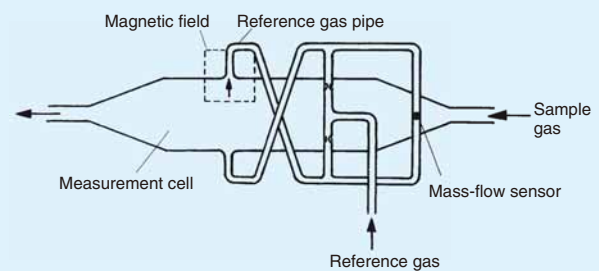

### Scarcely affected by interference gasses

ZAJ type case (Deviation of zero point caused by flowing interference gas component at 100%)

Interference gas	Deviation in O <sub>2</sub> %
NO	+43
CO	+0.01
CO <sub>2</sub>	-0.27
CH <sub>4</sub>	-0.20
He	+0.30
H <sub>2</sub>	+0.24
HCL	-0.30
NH <sub>3</sub>	-0.26
SO <sub>2</sub>	-0.22
N <sub>2</sub> O	-0.02
H <sub>2</sub> O	-0.02

# Reference gas needless ZKG-type

Type: ZKG



## FEATURES

- Response as high as 15 seconds.
- Hardly affected by other gases (such as H<sub>2</sub> and CO<sub>2</sub>).
- The front area measuring 220 x 443 mm is mounted flush with a panel.

## SPECIFICATIONS

- Measuring principle: Paramagnetic method (Dumbbell type)
- Measurement range: 0 to 10,25,50,100%O<sub>2</sub> (as specified)
- Numbers of range: 1 or 2 ranges (as specified)
- Repeatability: ±0.5%FS
- Linearity: ±1.0%FS
- Zero drift: ±2.0%FS/week
- Span drift: ±2.0%FS/week
- Response time: Within 15 seconds (From calibration gas inlet)
- Oxygen concentration output signal: 4 to 20mA DC or 0 to 1V DC
- Indication: 4-digit LED (Oxygen concentration indication) in red
- Power supply: 100 to 240V AC, 50/60 Hz
- Mounting method: Mounted flush on panel
- Outer dimensions: 190(W) x 240(H) x 234(D) mm

## ● ZKG type Gas Sampling System Diagram (Boiler exhaust gas example)

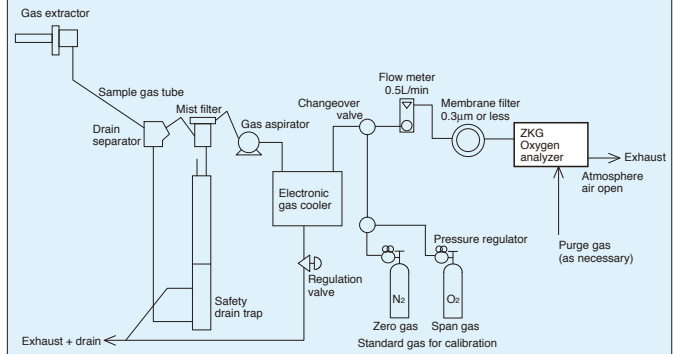

## ● ZKG type Measuring Principle Diagram

There are two glass spheres in the cell. When oxygen molecules flow there, they will be attracted toward the stronger magnetic field to cause a positional change of the spheres. The displacement of the spheres is detected with a light receiving element.

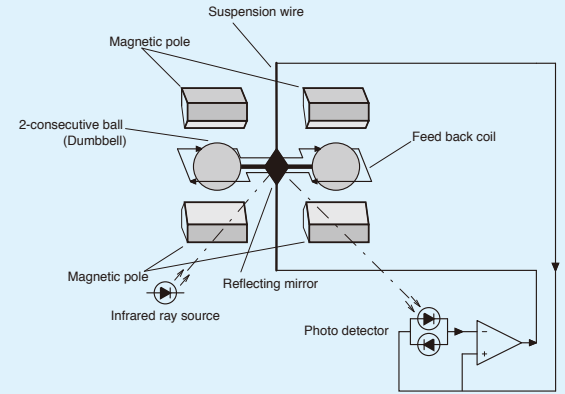

## Hardly affected by interference gasses

ZKG type case

Interference gas	Interference gas concentration	Deviation in O <sub>2</sub> %
NO	2000ppm	+0.15
CO	100%	+0.1
CO <sub>2</sub>	100%	-0.35
CH <sub>4</sub>	100%	-0.25



# CO<sub>2</sub> CONTROLLER

## Protected Horticulture

For growing sweet melon and strawberry in greenhouse.

## Storage of Fresh Produce

To create optimum environment for storage of fruit and vegetables.

## Building Air-conditioning

For control of room ventilation in a building and save energy due to cooling and heating.

### INFRARED CO<sub>2</sub> CONTROLLER with pump built-in

Type: ZFP



Aspirating pump, filter built in

#### FEATURES

- With built-in suction pump and filter.
- Two 1c (SPDT) relay contacts incorporated.
- Analog output signal incorporated.

#### SPECIFICATIONS

- Measuring object: CO<sub>2</sub> concentration in air
- Measuring system: Single beam type infrared method
- Measurement range: 0 to 0.2 ---- 20%
- Repeatability: ±1.0% of full scale
- Zero drift: ±10% of full scale/6 months
- Response speed: Within 10 seconds (90% response)
- Concentration output signal: 4 to 20mA DC or 0 to 100mV DC
- Alarm output: Relay contact (2x1c) Upper limit, lower limit
- Indicator: Moving coil type, JIS 2.5 class
- Gas sampling: Aspirating pump, filter built in
- Power supply: 100V, 115V, 200V, or 220V AC, 50/60Hz
- Sample gas temperature: 0 to 50°C
- Outer dimensions: 220(W) x 257(H) x 85(D) mm
- Mass (Weight): Approx. 3kg

### Recorder (Option)

### Paperless Recorder



#### ◇ SPECIFICATIONS

- Recording method: Built-in memory card
- Data format: ASCII (Data can be read directly into Excel), Binary (Data cannot be read directly into Excel)
- Storage capacity: 512MB, max. (Stores 3years data).
- Input points: 3 or 6 points
- Display contents: Trend, bar graph, digital, historical trend, event summary, etc.

Type: PHF

- Alarm indication: Upper/lower limit alarm indication (alarm output is option)
- Input signal: Thermocouples, resistance bulbs, voltage/current
- Indication accuracy: ±(0.15%+1 digit) of input range
- Power supply: 100 to 240V AC
- Outer dimensions: 160(W) x 144(H) x 185(D) mm
- Others: Standard-supplied PC support software

# Gas analyzer for heat treatment furnaces

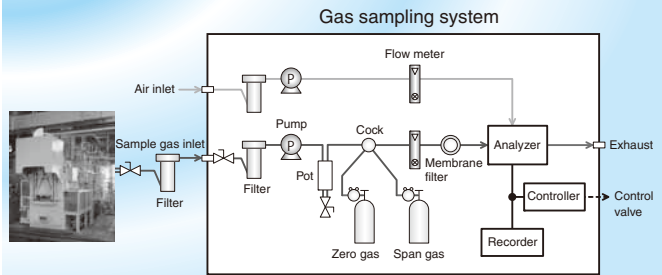

### Gas analyzer for heat treatment furnaces

Type: ZFG

#### FEATURES

- Gas concentration in the furnace can be measured accurately. Repeatability: Within ±0.5% of full scale
- Due to use of single beam system for measurement, an excellent stability is ensured for a long period of time and maintenance is easy.
- The analyzer is capable of measuring gas concentrations of CO<sub>2</sub>, CO and CH<sub>4</sub> components correlated to CP (carbon potential).
- CP calculation value can be displayed (option).
- The gas concentrations of 2 components of CO<sub>2</sub> + CO, CH<sub>4</sub> + CO, CO<sub>2</sub> + CH<sub>4</sub> can be measured simultaneously and continuously.



#### SPECIFICATIONS

- Measurable components: CO<sub>2</sub>, CO, CH<sub>4</sub>
- Measuring system: Single beam type infrared method
- Measurement range: CO<sub>2</sub>: 0 to 0.5 .....100%  
CO : 0 to 0.5 .....100%  
CH<sub>4</sub>: 0 to 1 .....10%
- Numbers of range: Max. 2 ranges
- Measurable components: Max. 2 components
- Repeatability: ±0.5% FS
- Drift: Within ±2.0% of full scale/week
- Response time: Less than 10 seconds (90% response from the device inlet)
- Output signal: 4 to 20mA DC or 0 to 100mV, 10mV DC
- Contact output: Instrument error, range identification signal
- Contact input: Remote range changeover, remote hold input
- Functions: CP calculation, output signal holding, Automatic OFF, etc
- Indication: LCD with back light
- Outer dimensions: 218(W) x 211(H) x 257(D) mm
- Power-supply voltage: 100 to 240V AC, 50/60Hz

# Thermal Conductivity Gas Analyzer



Type: ZAF

## FEATURES

- Easy-to-see large LCD is helpful for efficient operation.
- Measured value output signals are linearizable (at option).
- Line voltage lies within 100 V to 240 VAC, 50/60 Hz.
- Zero point and span can be automatically calibrated (at option).
- Other gases interference is correctable (at option).
- Communicable with other system through an RS-232C interface (MODBUS™)(at option).

## SPECIFICATIONS

- Measuring principle: Measurement of thermal conductivity
- Measurement component: He, Ar, H<sub>2</sub>, CH<sub>4</sub>, CO<sub>2</sub>
- Measurement range: Refer to Table 1
- Repeatability: ±1%FS
- Drift: Within ±2% of full scale/week
- Response time(90% response) : High speed type within 10 sec  
Standard type within 60 sec
- Output signal: 4 to 20mA DC or 0 to 1V DC, 0 to 10 mV DC
- Display unit: LCD with backlight
- Mounting: Flush mounting on panel
- Power supply: 100 to 240V AC, 50/60 Hz
- Optional specifications:
  - Linearization
  - Relay contact output
  - Contact input
  - Interference gas measured value input
  - Automatic calibration function
  - Communicating function

### Gas sampling system diagram (example)

Example of gas measurement in industrial furnace sintering furnace, etc.

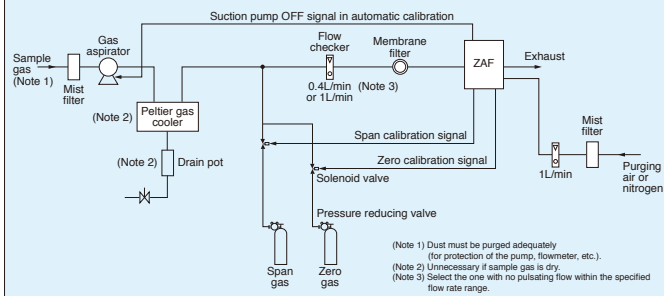

### Measuring principle

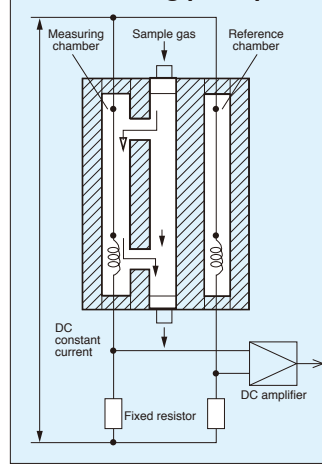

This thermal conductivity gas analyzer measures gas concentration by utilizing the different thermal conductivities of 2 gas components. In the detector, there are reference and measuring chambers in each of which a thin platinum wire is stretched. The reference chamber is filled with reference gas and through the measuring chamber, sample gas is flowed. Each platinum wire composes a bridge circuit in combination with an external fixed resistor, and it is heated by flowing a constant current. When there is a change in the concentration of the component under measurement, the thermal conductivity of sample gas will change to affect the temperature of the platinum wire in the measuring chamber. The resulting thermal change is taken out as a change in electric resistance, according to which the concentration of measured gas is calculated.

### Thermal Conductivity Ratio of Gases

Gases	Comparative thermal conductivity (0°C) when replacing thermal conductivity of air (2.41 × 10 <sup>-2</sup> w/(m.k)) with 1
Sulfur dioxide gas	SO <sub>2</sub>
Carbon dioxide gas	CO <sub>2</sub>
Argon	Ar
Carbon monoxide	CO
Steam (100°C)	H <sub>2</sub> O
Air	
Nitrogen	N <sub>2</sub>
Oxygen	O <sub>2</sub>
Methane	CH <sub>4</sub>
Hydrogen	H <sub>2</sub>

Table 1: Measurable Component and Measurable Range

Measured gas	Reference gas component (Note 1)	Measurable range	Range ratio (Note 2)
H <sub>2</sub>	N <sub>2</sub> , (CO <sub>2</sub> , Ar, He)	0 to 3, 5, 10, 20, 50, 80, 100% 100 to 90, 100 to 80%	1 : 10
He	N <sub>2</sub> , (CO <sub>2</sub> , Ar) O <sub>2</sub> , Air	0 to 5, 10, 20, 30, 40, 50, 80, 100% 100 to 90, 100 to 80%	1 : 10
Ar	N <sub>2</sub> , O <sub>2</sub> , Air, (He)	0 to 10, 20, 50, 80, 100% 100 to 90, 100 to 80%	1 : 5
CH <sub>4</sub>	N <sub>2</sub> , (CO <sub>2</sub> , Ar, He)	0 to 20, 40, 50, 60, 80, 100% 100 to 80%	1 : 5
CO <sub>2</sub>	N <sub>2</sub> , O <sub>2</sub> , Air, (He)	0 to 10, 20, 50, 100% 100 to 90, 80%	1 : 5

(Note 1) The parenthesized gases require inquiry.  
 (Note 2) Range ratio stands for maximum value.

### Other gases' interference

Indication error of each measured value (vol%)

Interference component	He meter	CH <sub>4</sub> meter	Ar meter	CO <sub>2</sub> meter
H <sub>2</sub> 1%	-	+5.8	-6.5	-8.0
CH <sub>4</sub> 1%	+0.17	-	-1.15	-1.38
SO <sub>2</sub> 1%	-0.31	-1.8	+2.1	+2.5
Ar 1%	-0.15	-0.87	-	+1.2
CO <sub>2</sub> 1%	-0.125	-0.725	+0.83	-
O <sub>2</sub> 1%	+0.019	+0.11	-0.125	-0.15
H <sub>2</sub> O 1.5°C saturation	-	-	-	-0.56

## AUTOMOBILE EXHAUST GAS ANALYZER

Type: ZKE



### SPECIFICATIONS

- Measuring components: HC, CO, CO<sub>2</sub>, O<sub>2</sub>
- Measurement range:
  - HC: 0 to 10000ppm
  - CO: 0 to 10%
  - CO<sub>2</sub>: 0 to 20%
  - O<sub>2</sub>: 0 to 25%
- Measuring method: Infrared ray system

O<sub>2</sub>: Galvanic sensor

- Certification number: JATA-CO, HC-5
- Communication interface: RS232C
- Indication: LCD with back light
- Power supply: 90 to 264V AC
- Outer dimensions: 270(W) x 156(H) x 365(D) mm
- Mass (Weight): Approx. 5kg

**Basic Principle = NDIR** \*NDIR: Non Dispersive Infrared Ray structure <Double beam type>

Certain gas absorbs certain range of infrared ray

It makes internal pressure in the left detector higher than one in the right detector.

By blocking the ray, the pressure in both detectors is equalized.

The changing volume of absorbing infrared ray is detected.

**● Infrared single light source**

There is less fluctuations of indication caused by the time lapsed of light source due to single source and dual beam method.

**Single Light Source Provides**

- Long Term Stability: ±0.5% to 2% FS/week

against dual light source.

→Both sources cannot be exactly same

→It creates error in measurement

Our test data of span drift for 28 days: Less than 1%FS

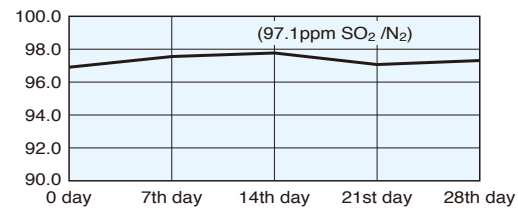

**● Drum type sector**

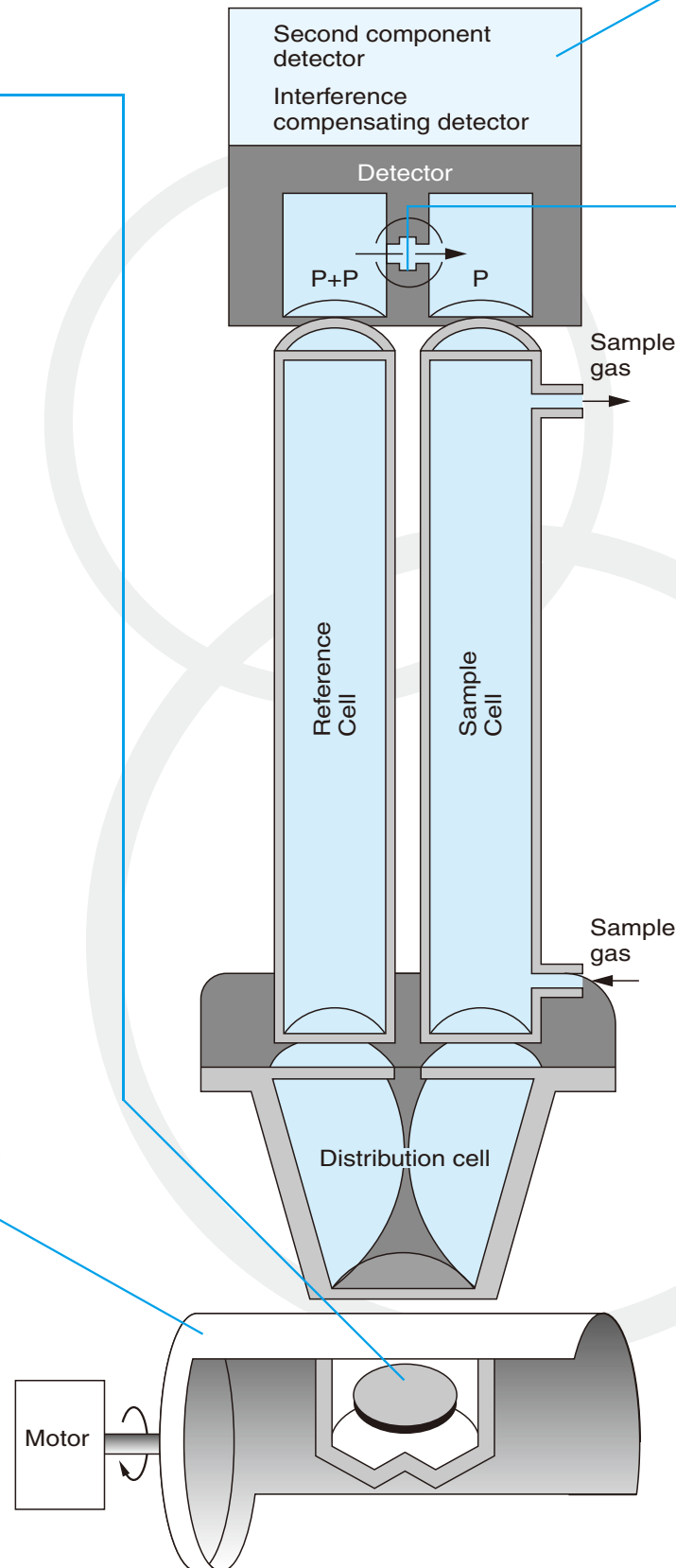

**● Interference Compensating Detector Eliminates**

- Interference of Moisture

Cross sensitivity to moisture: Less than 2 ppm at 2°C of saturated H<sub>2</sub>O

→Twin detector (Main detector + IC Detector) realizes excellent compensation.

Interference of moisture & CO<sub>2</sub> for NO measurement

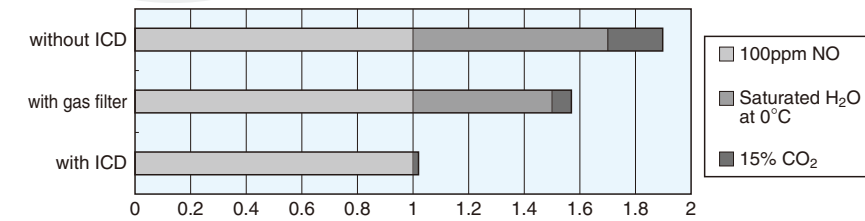

**● Mass-flow sensor**

**Basic Principle**

Resistance measurement (Detecting Temp. change by Pressure change)

- No moving parts
- Great Noise proof due to low impedance sensor
- High sensitive sensor introduces good linearity
- Impure gas in detector which causes interference can be removed by making full vacuum condition.

**Mass Flow Sensor Offers**

- 1) Excellent Linearity: ±1%FS
- 2) High Rangeability : 20 to 1 against condensor microphone (10 to 1)
- 3) Less Effect by Vibration No moving mechanical parts

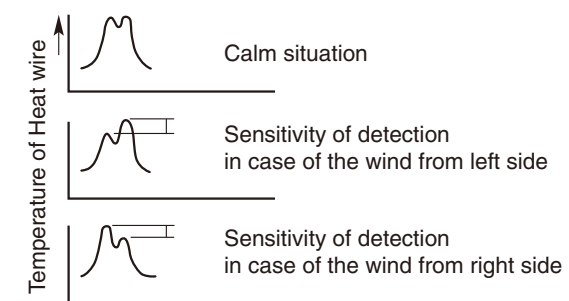
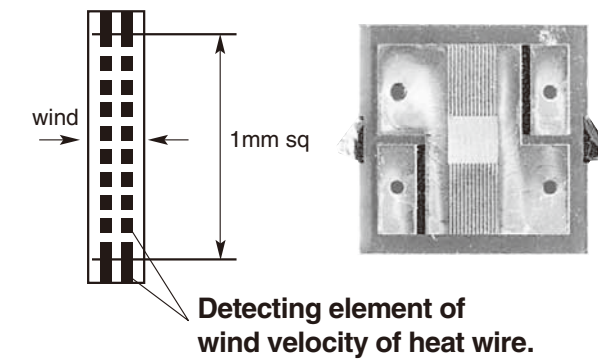

High sensitivity / High stability / High vibration proof.  
Super compact / Non-moving part

**● Single beam infrared analyzer (ZRE, ZRJ, ZFP)**

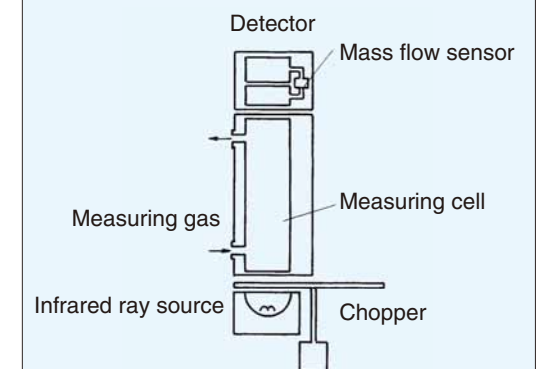

The dose of infrared-rays absorbed by measuring cell is detected with mass flow sensor.



## Gas Sampling System Diagram (Examples)

System components can be coordinated so as to match your application by utilizing rich experience.

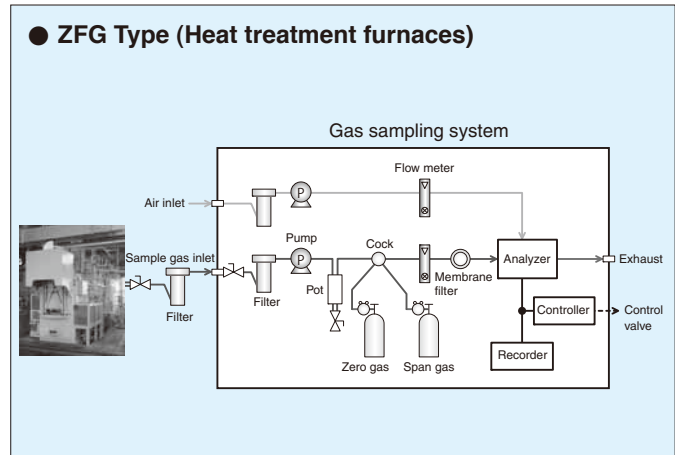
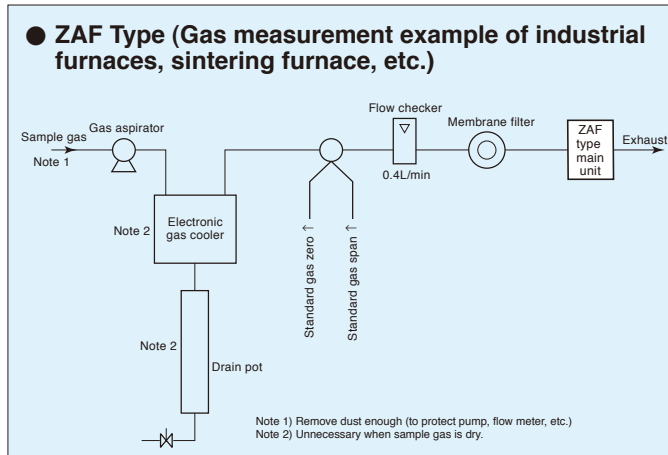
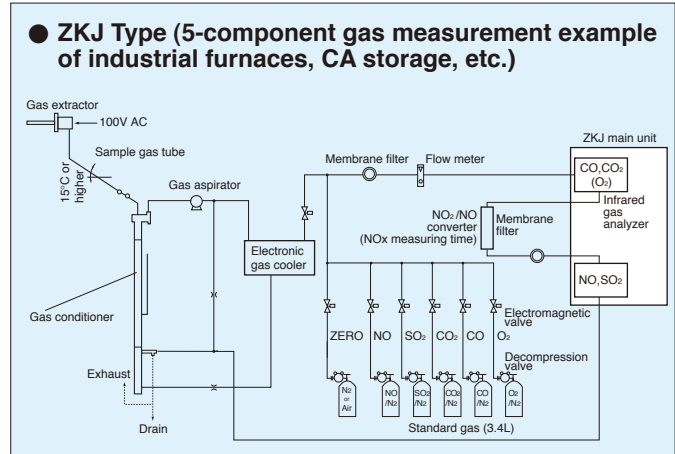
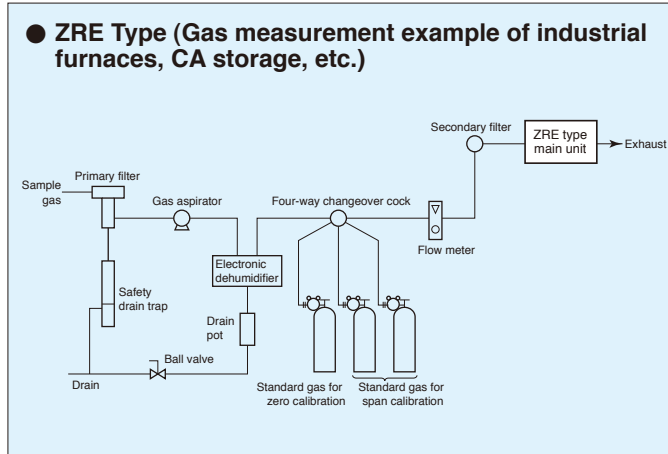

## Gas Sampling System Instrument

<p>● <b>Gas extractor (model: ZBA)</b></p>	<p>● <b>Gas Filter, Gas washing separator and washing nozzle (model: ZBB)</b></p>	<p>● <b>Peltier gas cooler (model: ZBC) Gas dryer (model: ZBJ)</b></p>
<p>● <b>Flow meter and regulator (model: ZBD)</b></p>	<p>● <b>Ball valves and selector valves (model: ZBF)</b></p>	<p>● <b>Gas aspirator (model: ZBG)</b></p>
<p>● <b>Drainings &amp; other (model: ZBH)</b></p>	<p>● <b>Gas converter (model: ZDL)</b></p> <p>(ZDL03) (ZDL21) (ZDL04)</p>	<p>● <b>Standard gas (model: ZBM)</b></p>

# Applications of Analyzer

	Application	Measured gas	Model
Air pollution	Incinerator	SO <sub>2</sub> , NO <sub>x</sub> , CO, CO <sub>2</sub> , O <sub>2</sub>	ZSQ, ZSU
	Desulfurization and denitration of exhaust gas	SO <sub>2</sub> , NO <sub>x</sub> , O <sub>2</sub> , NH <sub>3</sub>	ZSU, ZSS
	General combustion furnaces (including boilers)	SO <sub>2</sub> , NO <sub>x</sub> , O <sub>2</sub> , HCℓ	ZSU, ZSS
	Diesel generation	SO <sub>2</sub> , NO <sub>x</sub> , O <sub>2</sub>	ZSU, ZSV
	Automobile exhaust gas	CO, HC, CO <sub>2</sub> , O <sub>2</sub>	ZKE
Biochemistry (microbes)	For fermentation	methanol, CO <sub>2</sub>	ZRJ, ZSV, ZRE
	Incubator	CO <sub>2</sub> , O <sub>2</sub>	ZFP, ZKM, ZRJ, ZSV, ZRE
Ultra-low temperature	Superconduction device	He	ZAF
Storage and maturation of fruits		CO <sub>2</sub> , O <sub>2</sub>	ZFP, ZRJ, ZRE
Gas separation		O <sub>2</sub> , Ar, He, CO	ZAJ, ZAF, ZRJ, ZRE
Iron and steel	Blast furnace	CO, CO <sub>2</sub> , H <sub>2</sub> , O <sub>2</sub>	ZAF, ZAJ, ZRJ, ZRE, ZKM
	Converter funacer	CO, CO <sub>2</sub> , H <sub>2</sub> , O <sub>2</sub>	ZAF, ZAJ, ZRJ, ZRE, ZKM
	Heat treatment furnace	CO, CO <sub>2</sub> , O <sub>2</sub>	ZKM, ZRJ, ZRE
	Sintering (pellet equipment)	CO, CO <sub>2</sub> , O <sub>2</sub>	ZRJ, ZAJ, ZRE
	Coke oven (CDQ)	CO, CO <sub>2</sub> , H <sub>2</sub> , O <sub>2</sub>	ZAF, ZRJ, ZRE
Saving energy	Boiler, Heat treatment funacer	O <sub>2</sub> , CO <sub>2</sub> , CO	ZKM, ZSB, ZRE ZRJ, ZSQ, ZSU, ZSV
Hazard prevention	Detection of explosive gas (hydrocarbon gas and others)	HC	ZRJ
	Analysis of gases produced through combustion of new building materials	CO, CO <sub>2</sub> , HC, O <sub>2</sub>	ZRJ, ZRE
	Marine inert gas analysis	CO <sub>2</sub> , O <sub>2</sub>	ZRJ, ZRE, ZKM
Ceramic industry	Tunnel kiln	CO, O <sub>2</sub>	ZRJ, ZAJ, ZRE, ZSV
	Cement	CO, CO <sub>2</sub> , O <sub>2</sub>	ZRJ, ZAJ, ZRE, ZKG
Water and Sewerage water	Sewerage incinerator	SO <sub>2</sub> , NO <sub>x</sub> , CO, O <sub>2</sub>	ZSU
Thermal treatment	Generating furnace	CO <sub>2</sub>	ZRJ, ZRE, ZSV
	Carburization furnace	CO <sub>2</sub> , CO, O <sub>2</sub>	ZRJ, ZRE, ZSV
	Annealing furnace	CO <sub>2</sub> , CO, O <sub>2</sub>	ZRJ, ZRE, ZSV
	Nitration furnace	NH <sub>3</sub>	ZSS
Agriculture	Green house	CO <sub>2</sub>	ZFP, ZSV
	Reserch of photo synthesis	CO <sub>2</sub>	ZFP, ZRJ, ZRE, ZSV
Chemistry	Oil refining plant	CO, CO <sub>2</sub> , CH <sub>4</sub>	ZRJ, ZRE
	Petrochemical plant	CO, CO <sub>2</sub> , CH <sub>4</sub>	ZRJ, ZRE
	Gas production plant	CO, H <sub>2</sub> , He, Ar, O <sub>2</sub> , CO <sub>2</sub>	ZAF, ZRJ, ZRE
Electronics	Solder furnace	O <sub>2</sub>	ZKM
Environmental safeguard	Concentration in tunnel	CO	ZSA
	Parking area	CO, CO <sub>2</sub>	ZSA, ZFP
	Building management Building ventilation system	CO <sub>2</sub>	ZFP
Various scientific experiments	Laboratory	Various gases	ZFP, ZAJ, ZRJ, ZSV, ZRE
Fuel cell	Gas generation for fuel cell	H <sub>2</sub> , CH <sub>4</sub> , CO, CO <sub>2</sub>	ZRJ, ZAF, ZRE
Bio mass energy		CO, CO <sub>2</sub> , CH <sub>4</sub> , H <sub>2</sub> , O <sub>2</sub>	ZRJ, ZAF, ZSV, ZRE

# Examples of Application

## Most recommended for energy saving in air-conditioning of buildings is a CO<sub>2</sub> controller!

The CO<sub>2</sub> gas concentration in a room is required to be within 1,000 ppm by law in Japan. To meet this, the fresh outdoor air is always taken in. Control of the air intake at an appropriate level will save energy to run the air-conditioner for cooling and heating.

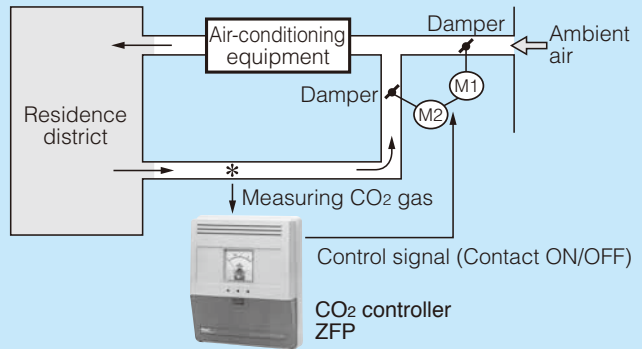

## CO/O<sub>2</sub> gas analyzers effective for curbing dioxins emission from waste incineration plants.

Continuous measurement of CO and O<sub>2</sub> concentrations in exhaust gas is obliged by antipollution ordinance and dioxin regulation.

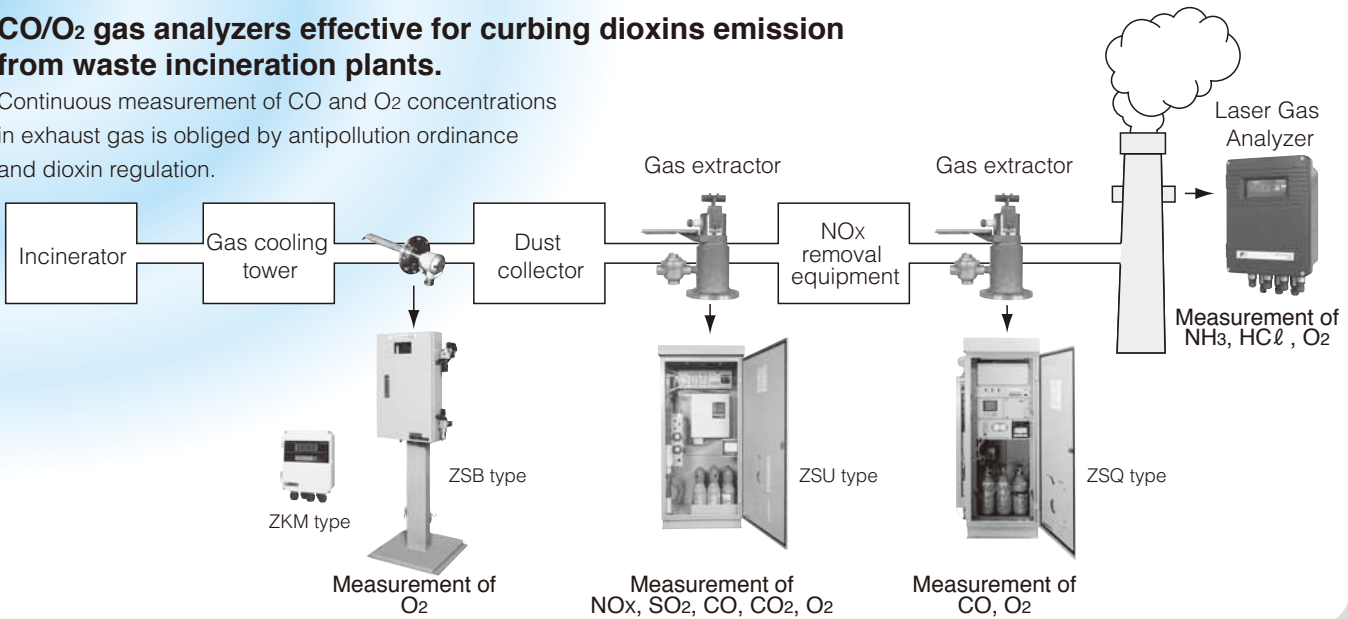

## NO<sub>x</sub>, SO<sub>2</sub>, CO and O<sub>2</sub>, HCl, NH<sub>3</sub> gas analyzers indispensable for combustion control and exhaust gas regulation of boilers.

Factories in an area under control of total air pollutant emission due to exhaust gas are obliged to measure NO<sub>x</sub> and SO<sub>2</sub> continuously.

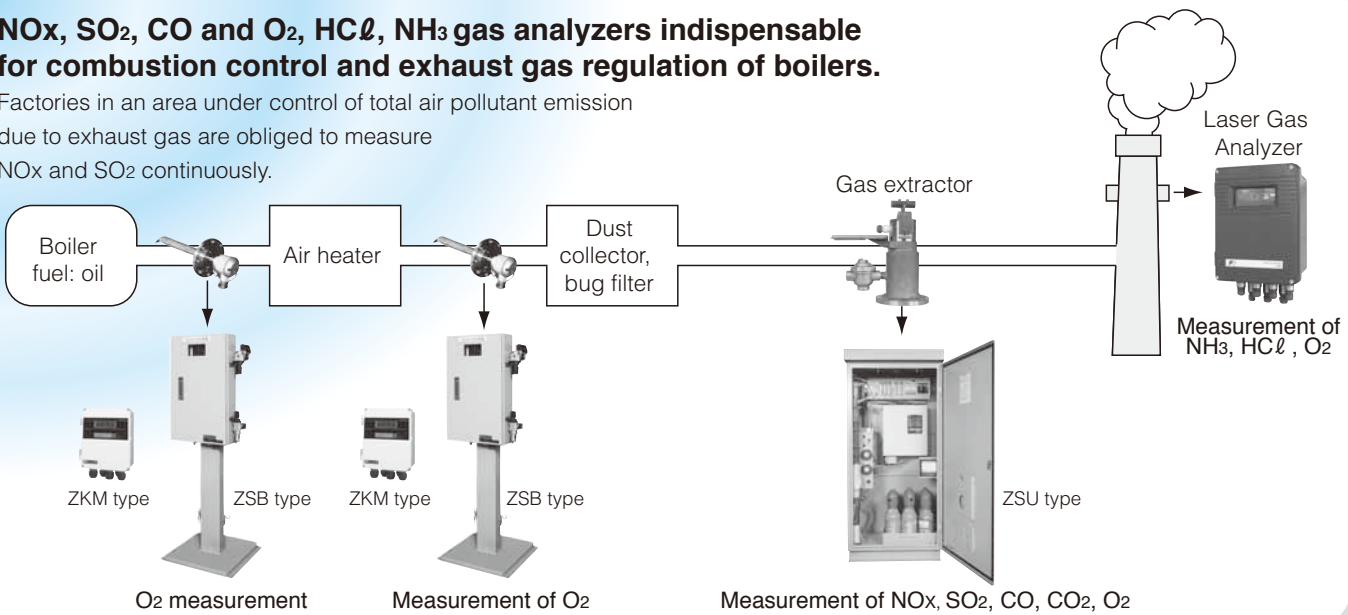



## Infrared CO<sub>2</sub> gas analyzers essential for measuring CO<sub>2</sub> and O<sub>2</sub> of heat treatment and reforming furnaces.

Propane and butane gases are brought into contact with a hot catalyzer to generate the gases to be supplied into a carburizing furnace. These gas analyzers measure each concentration of CO<sub>2</sub> and O<sub>2</sub> gases to be supplied into a carburizing furnace.

In iron treatment in a carburizing furnace, the CO<sub>2</sub> concentration of the in-furnace atmosphere is an index of furnace work.

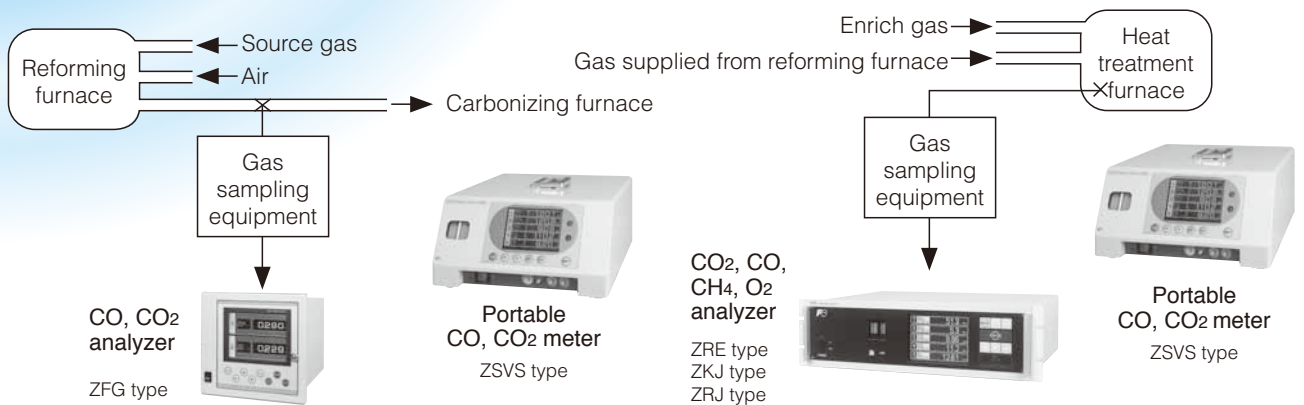

## Infrared CH<sub>4</sub>, CO<sub>2</sub> and O<sub>2</sub> gas analyzers optimum for bio-gas measurement.

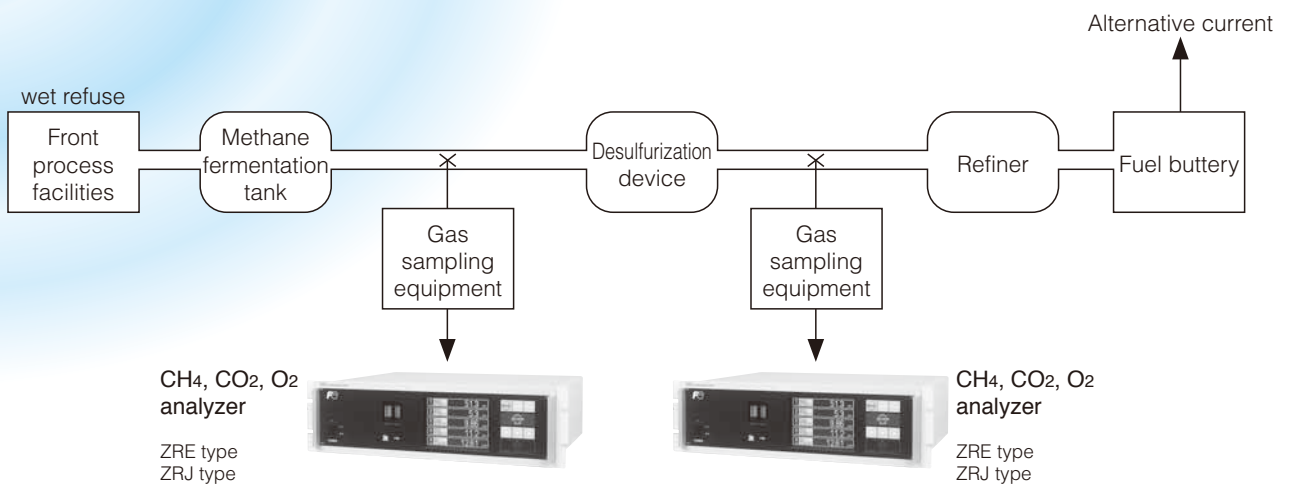

## Infrared CO<sub>2</sub> and O<sub>2</sub> gas analyzer for storage of foodstuffs such as vegetable and fruit.

Foodstuffs can be kept fresh by controlling the CO<sub>2</sub> and O<sub>2</sub> concentrations properly in a storage house.

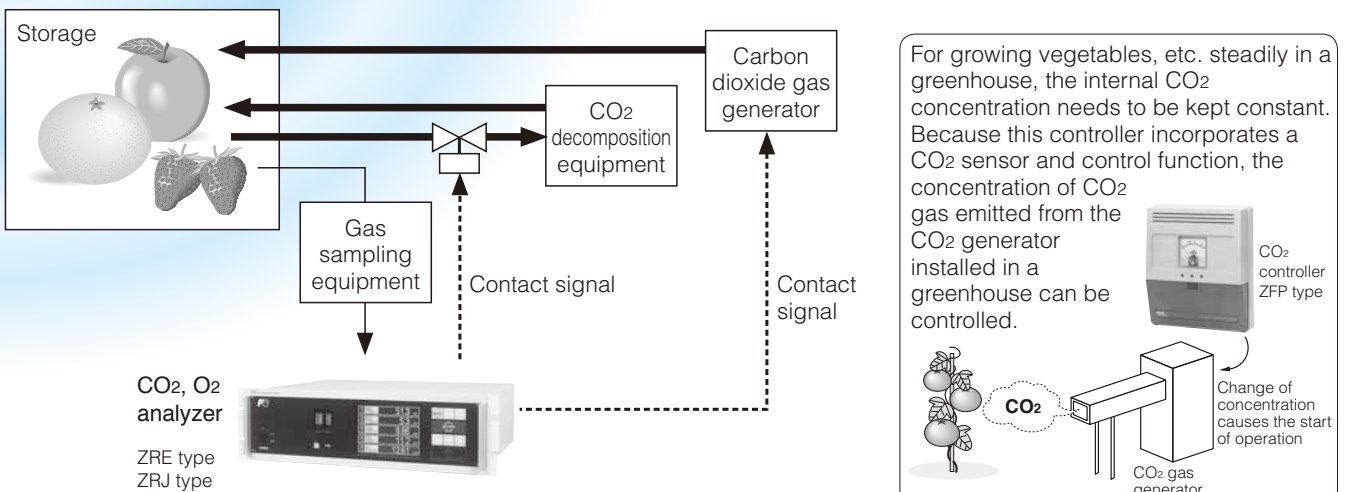



FUJI's aim is to preserve and protect the environment.